





I

ATTENZIONE: LA SICUREZZA DELL'APPARECCHIO È GARANTITA SOLO CON L'USO APPROPRIATO DELLE SEGUENTI ISTRUZIONI. CONSERVARLE CON CURA.

Prima di eseguire qualsiasi tipo di operazione togliere la tensione in rete.
Fare attenzione a non superare il Max di watt indicati per l'apparecchio.
L'apparecchio non può essere usato in ambienti umidi o all'esterno.
L'apparecchio non deve, in nessuna circostanza, essere coperto con materiale isolante o similare.
Mai coprire l'apparecchio durante il funzionamento.
Le parti laterali del vano dell'incasso devono distare almeno 50 mm dal corpo dell'apparecchio.

AVVERTENZE





Potenza massima della lampada. (1x 75W 25)** (1x 50W 40)***
Attacco lampada. GU10
Tipo lampada. 
Apparecchio classe II. 
Adatto al montaggio su superfici normalmente infiammabili. 
Grado di protezione. IP20
L'apparecchio deve essere equipaggiato con lampade autoprotette che non necessitano di schermo di protezione. 
Distanza minima dagli oggetti illuminati. 

GB

ATTENTION: THE SAFETY OF THE APPLIANCE IS GUARANTEED ONLY IF IT IS PROPERLY USED, ACCORDING TO THE FOLLOWING INSTRUCTIONS, WHICH ARE TO BE KEPT.

Always disconnect the power supply before installing or performing any maintenance operations.
Make attention of not exceeding the maximum watt indicated on the appliance.
The appliance may not be used in humid or external environments.
The luminaire shall. Under no circumstance, be covered with insulating matting or similar material.
Never cover the appliance while in function.
There must be more or less a distance of 50mm between the lateral space of the hole situated in recessed ceiling and the appliance.

WARNING





Capacity of bulb. (1x 75W 25)** (1x 50W 40)***
Type of lampholder. GU10
Type of bulb. 
Appliance in class II. 
Adaptable for mounting onto surfaces normally inflammable. 
Degree of protection. IP20
The symbol mains the use of self-protection lamps which don't need of any protection screen. 
Minimum distance from lighted objects. 

D

ACHTUNG: DIE SICHERHEIT DIESER BELEUCHTUNGSKÖRPERS WIRD NUR DURCH DIE KORREKTE ANWENDUNG DER NACHSTEHENDEN ANWEISUNGEN GEWÄHRLEISTET. DIESE ÜSSEN DAHER SORGFÄLTIG AUFBEWAHRT WERDEN.:

Bevor irgendwelche Arbeitsgänge ausgeführt werden, muß die Stromversorgung unterbrochen.
Achten Sie darauf, daß die auf dem Beleuchtungskörper angegebene maximale Wattzahl nicht überschritten wird.
Der Beleuchtungskörper darf nicht in feuchten Räumen bzw. im Freien eingesetzt werden.
Das Gerät muß NIE mit Isoliermaterial oder ähnlichen Materialien bedeckt werden.
Den Beleuchtungskörper während dem Betrieb nicht abdecken.
Die Seitenwände der Unterbauöffnung müssen mindestens 50 mm vom Lampenkörper entfernt sein.

WICHTIGE HINWEISE





Leistung der Gluebirne. (1x 75W 25)** (1x 50W 40)***
Anschluss. GU10
Typ der Gluebirne. 
Gerat der Klasse II. 
Schutzart. IP20
Das Gerat eignet sich fuer die Montage auf normal entflammaren Oberflaechen. 
Die Geräte dürfen ausschließlic nur mit selbstschützenden Leuchtmitteln benutzt werden, die keine Schutzgläser benötigen 
Mindestabstand: Zwischen den Glühmitteln und dem 

RU

ВНИМАНИЕ: БЕЗОПАСНОСТЬ ОСВЕТИТЕЛЬНОГО ПРИБОРА ГАРАНТИРОВАНА ТОЛЬКО ПРИ УСЛОВИИ ЕГО ЭКСПЛУАТАЦИИ В СООТВЕТСТВИИ С ПРИВЕДЕННЫМИ НИЖЕ ИНСТРУКЦИЯМИ, КОТОРЫЕ НЕОБХОДИМО СОХРАНИТЬ.

Перед выполнением любой операции с осветительным прибором отключить напряжение в сети.
Не превышать максимально допустимую мощность, указанную для данного осветительного прибора.
Осветительный прибор не может быть использован во влажных помещениях или на улице.
The luminaire shall. Under no circumstance, be covered with insulating matting or similar material.
Никогда не накрывать осветительный прибор в рабочем режиме.
Боковые поверхности ниши должны находиться на расстоянии 50 мм от корпуса осветительного прибора.

ВНИМАНИЕ





Максимальная мощность лампочки. (1x 75W 25)** (1x 50W 40)***
Тип цоколя лампочки. GU10
Тип лампочки. 
Степень защиты. IP20
Осветительный прибор КЛАССА II. 
пригодный для установки на возгораемых поверхностях. 
Рекомендуется снабжать осветительный прибор самозащитными лампами, не нуждающимися в защитного экрана 
Минимальное расстояние от освещаемых предметов 

F

ATTENTION: LA SECURITE DE CET APPAREIL N'EST GARANTIE QUE SI L'ON RESPECTE LES INSTRUCTIONS SUIVANTES. IL EST, PAR CONSEQUENT, INDISPENSABLE DE LES CONSERVER SOIGNEUSEMENT.

Avant d'effectuer toute opération, débrancher la tension de réseau.
Veiller à ne pas dépasser la limite maximale des watts indiquée sur l'appareil.
Cet appareil ne peut pas être utilisé dans des pièces humides ni à l'extérieur.
L'appareil ne doit absolument pas être recouvert avec matériel isolant ou similaire.
Ne jamais couvrir l'appareil pendant son fonctionnement.
Veiller à respecter une distance minimale de 50 mm entre le corps de l'appareil et les parois latérales du logement d'encastrement.

AVERTISSEMENTS





Puissance ampoule. (1x 75W 25)** (1x 50W 40)***
Culot. GU10
Type ampoule. 
Appareil de classe II. 
Degré de protection. IP20
Appareil apte au montage sur surfaces normalement inflammables. 
L'appareil doit être équipé avec ampoules masquées. écran de protection non nécessaire 
Distance minime des objets eclaires. 

P

ATENÇÃO: A SEGURANÇA DO APARELHO É GARANTIDA SOMENTE SE FOREM RESPEITADAS AS INSTRUÇÕES. PORTANTO, É NECESSÁRIO CONSERVÁ-LAS.

Antes de fazer qualquer tipo de operação, desligar a corrente eléctrica da rede.
Prestar atenção para não superar o número de watts indicados para o aparelho.
O aparelho não pode ser utilizado em ambientes húmidos ou no exterior.
The luminaire shall. Under no circumstance, be covered with insulating matting or similar material.
Nunca cobrir o aparelho durante o funcionamento.
There must be more or less a distance of 50mm between the lateral space of the ole situated in recessed ceiling and the appliance.

ADVERTÊNCIAS





Potência máxima da lâmpada. (1x 75W 25)** (1x 50W 40)***
Tipo de suporte da lâmpada. GU10
Tipo de lâmpada. 
Aparelho de CLASSE II. 
Apropriado para ser montado em superficies normalmente inflamáveis. 
Grado de protecção. IP20
Este símbolo significa o uso de lâmpadas protegidas, as quais não necessitam protecção adicional 
Distância mínima : entre a lâmpada e o objeto 

E

ATENCIÓN: LA SEGURIDAD DEL APARATO ESTÁ GARANTIZADA SÓLO POR UN USO ADECUADO DE LAS SIGUIENTES INSTRUCCIONES; POR CONSIGUIENTE, ES PRECISO CONSERVARLAS.

Antes de llevar a cabo cualquier tipo de operación, desconectar la tensión de la red.
Prestar atención a no superar el máximo de los vatios indicados en el aparato.
El aparato no podrá utilizarse en ambientes húmedos ni en exteriores.
El aparato en ninguna circunstancia tiene que estar cubierto con material aislante o parecido.
No cubrir jamás el aparato durante el funcionamiento.
Las paredes laterales del hueco del empotrado tienen que distar por los menos 50 mm del cuerpo del aparato.

ADVERTENCIAS

Potencia máxima de la bombilla. (1x 75W 25)** (1x 50W 40)***
Casquillo de la bombilla. GU10
Tipo de bombilla. 
Aparato CLASE II. 
Aparato adecuado para el montaje en superficies normalmente inflamables. 
Grado de protección. IP 20
El aparato tiene que estar provisto de bombillas autoprotégidas que no necesitan la pantalla de protección. 
Distancia mínima de los objetos alumbrados. 

-Procedere al montaggio, eseguendo le operazioni in ordine numerico progressivo.
 -Proceed with assembling following the operations in progressive numerical order.
 -Arbeitsgänge in numerischer Ordnung ausführen, um das Gerät zu installieren.
 -Il faut procéder a le montage exécutant les opérations par l'ordre numérique progressif.

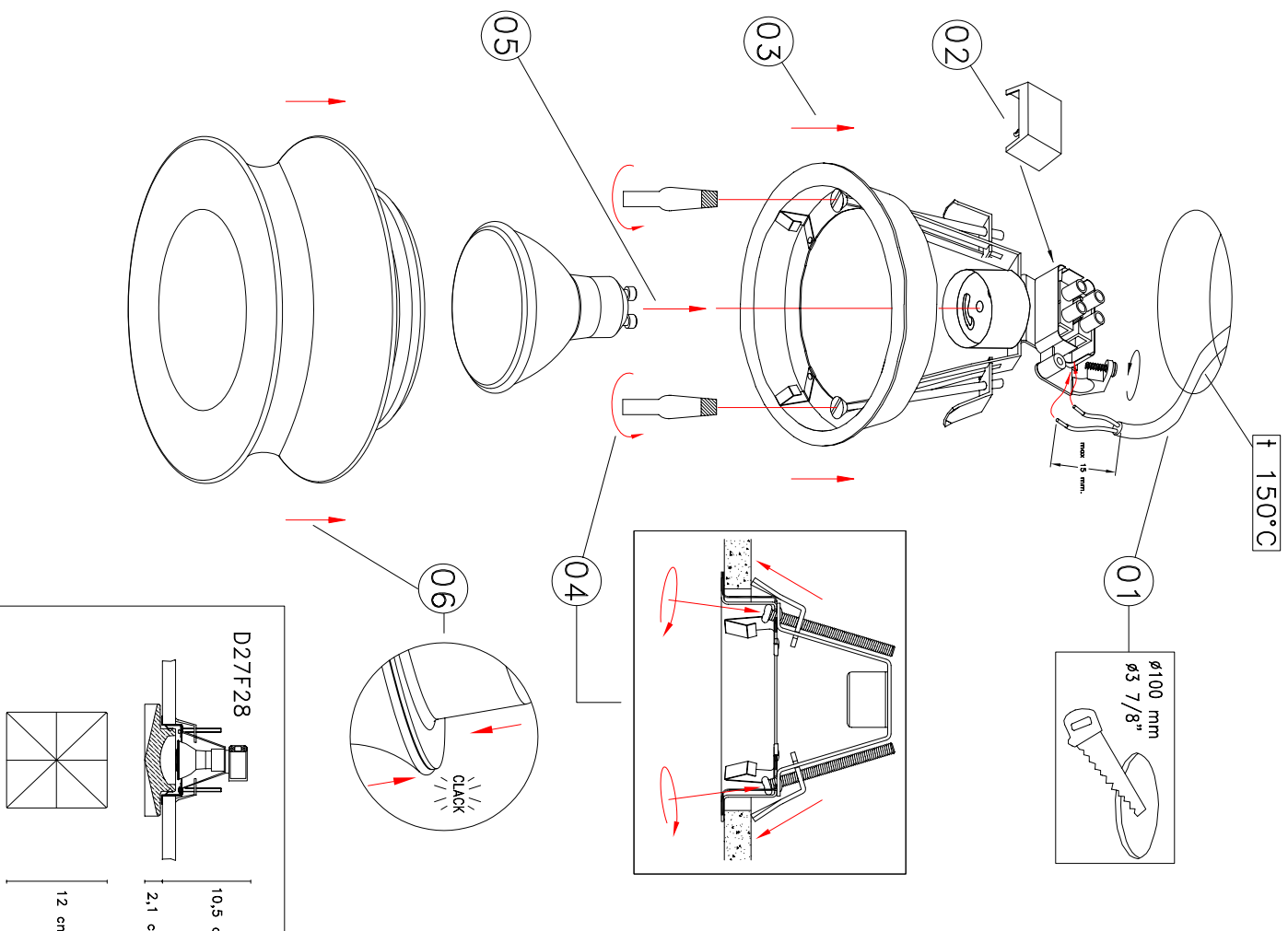

 D27F03 10,5 cm 2,4 cm	 D27F05 10,5 cm 1,6 cm	 D27F07 10,5 cm 4 cm
 D27F01 10,5 cm 3,3 cm	 D27F09-F66 10,5 cm 2,4 cm	 D27F11 10,5 cm 2,4 cm
 D27F13 10,5 cm 1,6 cm	 D27F15 10,5 cm 1,6 cm	 D27F17 10,5 cm 3,3 cm
 D27F28 10,5 cm 2,1 cm	 D27F51 10,5 cm 4,3 cm	 D27F56 10,5 cm 3,2 cm
 D27F61 10,5 cm 3,5 cm		

D27 FARETTI D27F01-F03-F05-F07-F09-F11-F13-F15-F17-F28-F51-F56-F61-F66