

Fabbian50 via Santa Brigida
3102 0 Castelminio di Resana
Treviso, Italy Tel +39 0423 4848 fax +39 423 484395
fabbian@fabbian.com www.fabbian.com**CUBETTO**
D28A01 D28A51 D28J01**I****ATTENZIONE: LA SICUREZZA DELL'APPARECCHIO È GARANTITA SOLO CON L'USO APPROPRIATO DELLE SEGUENTI ISTRUZIONI. CONSERVARLE CON CURA.****AVVERTENZE**

Prima di eseguire qualsiasi tipo di operazione togliere la tensione in rete.
Fare attenzione a non superare il Max di watt indicati per l'apparecchio.
L'apparecchio non può essere usato in ambienti umidi o all'esterno.
Mai coprire l'apparecchio durante il funzionamento.
Per la pulizia dei vetri si raccomanda di non usare mai abrasivi o solventi.

L'apparecchio deve essere equipaggiato con lampade autoprotette che non necessitano di schermo di protezione.

Potenza massima della lampada. 1x 50W

Attacco lampada. GU10

Tipo lampada. Apparecchio classe II 

Classe di protezione. IP20

Distanza minima dagli oggetti illuminati. Minimum distance from lighted objects. **GB****ATTENTION: THE SAFETY OF THE APPLIANCE IS GUARANTEED ONLY IF IT IS PROPERLY USED, ACCORDING TO THE FOLLOWING INSTRUCTIONS, WHICH ARE TO BE KEPT.****WARNING**

Always disconnect the power supply before installing or performing any maintenance operations.
Make attention of not exceeding the maximum watt indicated on the appliance.
The appliance may not be used in humid or external environments.
Never cover the appliance while in function.
For cleaning the glass do not use any abrasive or solvent materials.

The symbol mains the use of self-protection lamps which don't need of any protection screen.

Capacity of bulb. 1x 50W

Type of lampholder. GU10

Type of bulb. Appliance in class II 

Protection class. IP20

Minimum distance from lighted objects. Minimum distance from lighted objects. **D****ACHTUNG: DIE SICHERHEIT DIESER BELEUCHTUNGSKÖRPER WIRD NUR DURCH DIE KORREKTE ANWENDUNG DER NACHSTEHENDEN ANWEISUNGEN GEWÄHRLESTET. DIESE ÜSSEN DAHER SORGFÄLIG AUFBEWAHRT WERDEN.****WICHTIGE HINWEISE**

Die Netzversorgungskabel mit den entsprechenden Kabelmänneln aus Silikonglas schützen.
Bevor irgendwelche Arbeitsgänge ausgeführt werden, muß die Stromversorgung unterbrochen.
Den Beleuchtungskörper während dem Betrieb nicht abdecken.
Achten Sie darauf, daß die auf dem Beleuchtungskörper angegebene maximale Wattzahl nicht überschritten wird.
Der Beleuchtungskörper darf nicht in feuchten Räumen bzw. im Freien eingesetzt werden.

The symbol mains the use of self-protection lamps which don't need of any protection screen.

Leistung der Gluehbirne. 1x 50W

Anschluss. GU10

Typ der Gluehbirne. Gerat der Klasse II 

Schutzklasse IP20

Minimum distance from lighted objects. Minimum distance from lighted objects. **RU****ВНИМАНИЕ: БЕЗОПАСНОСТЬ ОСВЕТИТЕЛЬНОГО ПРИБОРА ГАРАНТИРОВАНА ТОЛЬКО ПРИ УСЛОВИИ ЕГО ЭКСПЛУАТАЦИИ В СООТВЕТСТВИИ С ПРИВЕДЕННЫМИ НИЖЕ ИНСТРУКЦИЯМИ, КОТОРЫЕ НЕОБХОДИМО СОХРАНИТЬ.****ВНИМАНИЕ:**

Не превышать максимально допустимую мощность, указанную для данного осветительного прибора.
Перед выполнением любой операции с осветительным прибором отключить напряжение в сети.
Осветительный прибор не может быть использован во влажных помещениях или на улице.
Никогда не накрывать осветительный прибор в рабочем режиме.
For cleaning the glass do not use any abrasive or solvent materials.



The symbol mains the use of self-protection lamps which don't need of any protection screen.

Максимальная мощность лампочки 1x 50W

Тип цоколя лампочки GU10

Тип лампочки Осветительный прибор КЛАССА II 

Класс защиты IP20

Minimum distance from lighted objects. Minimum distance from lighted objects. **F****ATTENTION: LA SECURITE DE CET APPAREIL N'EST GARANTIE QUE SI L'ON RESPECTE LES INSTRUCTIONS SUIVANTES. IL EST, PAR CONSEQUENT, INDISPENSABLE DE LES CONSERVER SOIGNEUSEMENT.****AVERTISSEMENTS**

Avant d'effectuer toute opération, débrancher la tension de réseau.
Veiller à ne pas dépasser la limite maximale des watts indiquée sur l'appareil.
Ne jamais couvrir l'appareil pendant son fonctionnement.
Cet appareil ne peut pas être utilisé dans des pièces humides ni à l'extérieur.
Ne jamais utiliser des abrasifs ou des solvants pour le nettoyage des parties en verre.

The symbol mains the use of self-protection lamps which don't need of any protection screen .

Puissance ampoule. 1x 50W

Culot. GU10

Type ampoule. Appareil de classe II 

Classe de protection. IP20

Minimum distance from lighted objects. Minimum distance from lighted objects. **P****ATENÇÃO: A SEGURANÇA DO APARELHO É GARANTIDA SOMENTE SE FOREM RESPEITADAS AS INSTRUÇÕES. PORTANTO, É NECESSÁRIO CONSERVÁ-LAS.****ADVERTÊNCIAS**

Antes de fazer qualquer tipo de operação, desligar a corrente eléctrica da rede.
Prestar atenção para não superar o número de watts indicados para o aparelho.
O aparelho não pode ser utilizado em ambientes húmidos ou no exterior.
Nunca cobrir o aparelho durante o funcionamento.
For cleaning the glass do not use any abrasive or solvent materials.

The symbol mains the use of self-protection lamps which don't need of any protection screen.

Potência máxima da lâmpada. 1x 50W

Tipo de suporte da lâmpada. GU10

Tipo de lâmpada. Aparelho de CLASSE II 

Classe de protecção. IP20

Minimum distance from lighted objects. Minimum distance from lighted objects. **E****ATENCIÓN: LA SEGURIDAD DEL APARATO ESTÁ GARANTIZADA SÓLO POR UN USO ADECUADO DE LAS SIGUIENTES INSTRUCCIONES; POR CONSIGUIENTE, ES PRECISO CONSERVARLAS.****ADVERTENCIAS**

Antes de llevar a cabo cualquier tipo de operación, desconectar la tensión de la red.
Prestar atención a no superar el máximo de los vatios indicados en el aparato.
El aparato no podrá utilizarse en ambientes húmedos ni en exteriores.
No cubrir jamás el aparato durante el funcionamiento.
For cleaning the glass do not use any abrasive or solvent

The symbol mains the use of self-protection lamps which don't need of any protection screen .

Potencia máxima de la bombilla. 1x 50W

Casquillo de la bombilla. GU10

Tipo de bombilla. Aparato CLASE II 

Clase de protección IP20

Minimum distance from lighted objects. Minimum distance from lighted objects. 

- Procedere al montaggio seguendo le operazioni in ordine numerico progressivo.
- Proceed with assembling following the operations in progressive numerical order.
- Arbeitsgänge in numerischer Ordnung ausführen, um das Gerät zu installieren.
- Il faut procéder a le montage exécutant les opératoins par l'ordre numerique progressif.

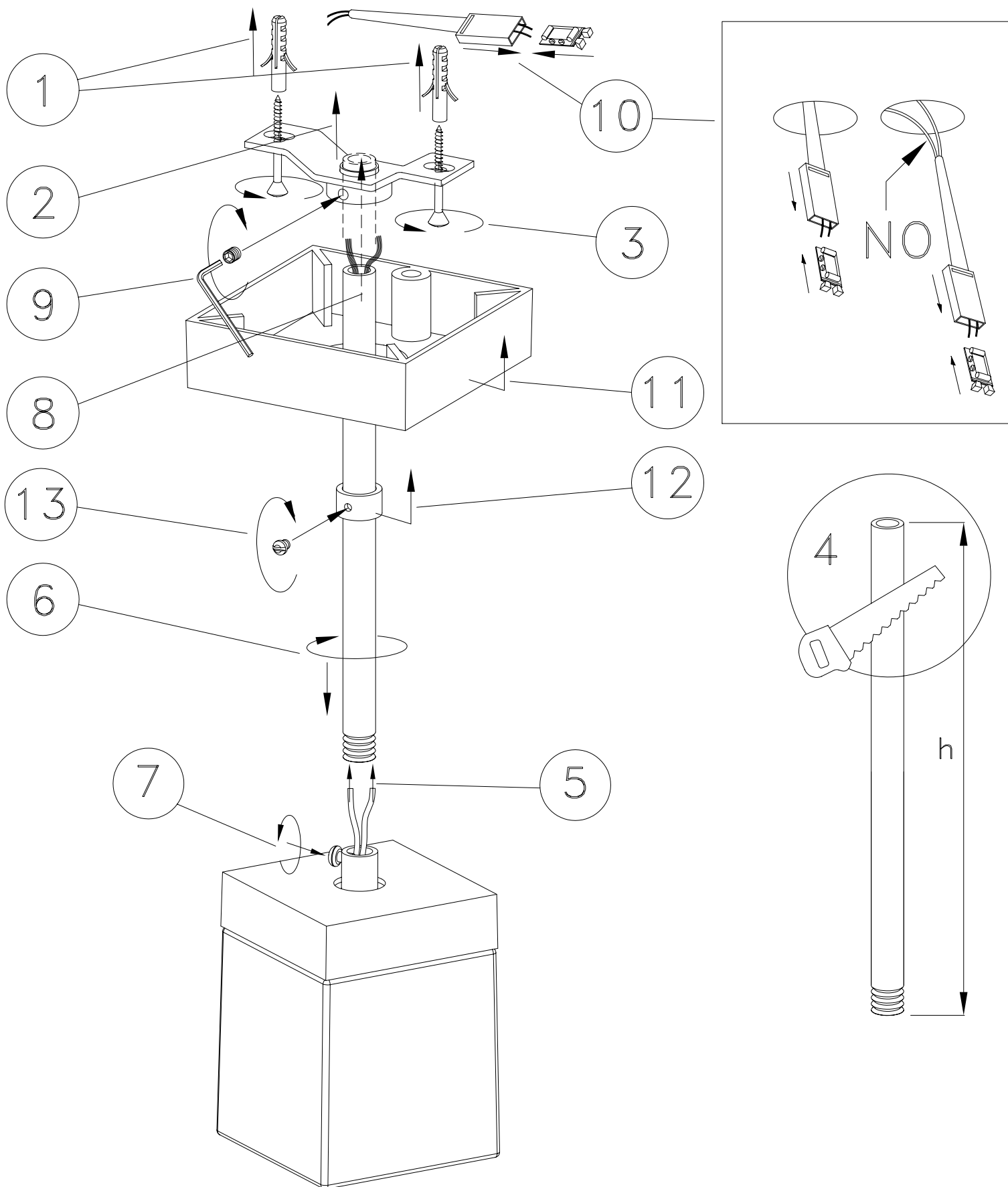

D28A01
D28A51



ATTENTION:

- Con vetro NERO usare solamente lampadina con attacco GU10
- BLACK glass use only lamp GU10
- Verre NOIR à utiliser seulement avec lampe GU10
- SCHWARZES Glas benutzbar nur mit der GU10 leuchte